



### Technical Manual

Please read this manual carefully before using your SUPA heater, and keep it for future reference.

Thank you for choosing to purchase a SUPA heater. If a problem occurs during its use, please refer to this manual or the FAQ's at [www.supa-heater.com](http://www.supa-heater.com).

SUPA Products Limited will not be held liable for any accidents, damage, injuries or sickness caused by failure to follow the guidance and instructions provided herein.

Any images shown in this manual are for reference only, please refer to the actual product.

The information provided in this manual is subject to change without notice. For the version particular to your generation of SUPA, please refer to [supa-heater.com](http://supa-heater.com).

## Contents:

1. Repair
2. Danger of Noxious Gases
3. Prevention of Gas Accidents
4. Fire Prevention
5. Prevention of Carbon Monoxide Poisoning
6. Prevention of Burns to the Skin
7. General Information
8. Product Introduction
9. Anti-Freeze Protection
10. Overheating Protection
11. Timing Protection
12. Intelligently Constant Temperature
13. Ease of Operation
14. Outlet Water Temperature Display
15. Flue Blockage or Fan Failure Protection
16. Automatic Fault Diagnosis and Display
17. Technical Information
18. Electrical Wiring Plan
19. Assembly
20. Operating Instructions
21. General Maintenance
22. User Maintenance and Information
23. Error Codes

## Regulatory Compliance:

SUPA complies with the following essential requirements of the regulations for appliances burning gaseous fuels (EU) 2016/426 Annex III, 1:

1. Low Voltage Directive (2014/35/EU), and 2. EMC-directive (2014/30/EU)

## The following harmonized standards have been applied :

By choosing SUPA heater you have purchased an innovative water heater specifically designed to heat a Hot Tub or offer portable hot water whenever or wherever you wish. SUPA has been rigorously tested to ensure compliance with the latest regulatory standards for safety, performance and emissions using the following European safety standards:

1. EN 26:2015

Relevant LVD standards:	Relevant EMC standards:
IEC 60335-1: 2010 + A1: 2013 + AW: 2016 IEC 60335-2-102: 2017 EN 60335-1: 2012 + A11: 2014 + A13: 2017 EN 62233: 2008	EN 55014-1: 2017 EN 55014-2: 2015 EN IEC 61000-3-2: 2019 EN 61000-3-3: 2013

## 1. REPAIR

SUPA heater can only be repaired, dismantled and modified by professional CORGI approved gas fired heating engineers. Any unauthorised dismantling, repair and/or modifying of SUPA heater will infringe our Terms and Conditions and void the warranty. SUPA Products limited will not be held responsible for any failures or accidents that may occur due to these actions.

## 2. DANGER OF NOXIOUS GASSES

When the water heater is working, gas combustion consumes a large amount of oxygen and generates carbon monoxide. Inhaling carbon monoxide gas can cause injury or death. Therefore, the user must install and use the water heater strictly in accordance with the requirements of this manual. SUPA Products Limited will not assume legal responsibility for any consequences caused by a misuse of the product outside the specific requirements of this manual. **NEVER use SUPA heater indoors.**

## 3. PREVENTION OF GAS ACCIDENTS

- a. The type of gas used must be the same as that specified on the nameplate of the water heater (Propane).
- b. Please ensure that the correct low-pressure regulator and gas piping are used – seek advice from your local specialist gas bottle provider – in the UK this is 37 mbar. SUPA heater will only work with a screw in gas regulator. It will not work with an easy-fit, clip on regulator.
- c. After each use, please ensure that your SUPA heater and pump are switched off and the gas valve is closed.
- d. If you smell gas, use soapy water to check each gas joint for leaks. If a gas leak is found, immediately shut off the gas source and SUPA heater and allow the gas to disperse. If the leak is associated with the gas hose or regulator, tighten all fittings and establish if this stops the leak using soapy water again. If the leak is not stopped, then turn off the gas and replace the potentially defective gas hose and regulator. If this does not resolve the problem then consult a CORGI approved gas engineer to review and remedy the issue.
- e. Gas hoses may leak due to cracks after prolonged use. Check them frequently. Under normal circumstances we suggest that hoses are replaced annually.
- f. If you find that the combustion flame within the SUPA heater is suddenly high or low, it is likely that the regulator valve connected to the gas outlet of the water heater has failed. You should stop using it immediately and replace it.
- g. If the gas supply pressure is insufficient, a flashback phenomenon can be caused which will affect the normal operation of the heater. If this happens, the flame changes from blue to yellow with an abnormal sound of buzzing from the burner. This leads to a significant increase in carbon monoxide emissions in the exhaust flue gas. Stop using SUPA heater immediately, and contact a suitably qualified CORGI approved gas engineer should be called.

## 4. FIRE PREVENTION

- a. **NEVER** leave your SUPA heater unattended when in use.
- b. **NEVER** place towels, clothing and other flammable items near the exhaust and gas supply ports of SUPA heater.
- c. **NEVER** store flammable, explosive and volatile materials where SUPA heater is in use or stored.
- d. **NEVER** invert or position the LPG cylinder sideways. Liquid fuel may accumulate in the neck of the

bottle, which will be forced into the heater and cause a fire.

- e. SUPA heater must only be used vertically. If it is installed obliquely, such as leaning against a wall, this will cause the burner flame to make contact with the internal wiring of the heater, risking a fire.
- f. Should the heater topple over, it will automatically stop. Once stood upright, it will function normally.

## 5. PREVENTION OF CARBON MONIOXIDE POISONING

- a. SUPA heater is a forced exhaust water heater, so the provided exhaust flue and cowl MUST be connected to the exhaust port of the heater. This is in order to safely discharge the combustion exhaust gasses away from the heater. It is necessary to maintain good air circulation around the exhaust flue and heater body at all times. A potential build-up of fumes or incomplete combustion may cause injury or death.
- b. Since the gas supply pressure directly affects the combustion performance of the heater, users must choose a pressure reducing valve that conforms to national standards. This is 37 mbar for the UK. Consult your local LPG supplier for specialist advice.
- c. Ensure that the type of gas used is consistent with the type of gas specified on the nameplate of the water heater (Propane).
- d. Ensure exhaust gasses are readily dispersed and cannot accumulate. **NEVER use SUPA heater in a confined space.**
- e. After long-term use, dust and carbon deposits will block the heat exchanger and affect the performance of the heater. This will directly result in the increase of carbon monoxide emissions in the flue gas, which may cause injury or death. Therefore, we suggest that a qualified CORGI approved gas engineer be engaged to remove dust and carbon deposits on the heat exchanger plate every twelve months. This is to ensure that the flue gas emissions meet the national safety standards.

## 6. PREVENTION OF BURNS TO THE SKIN

- a. When heating your Hot Tub using MODE 1, the output water temperature through the red outlet hose can reach 70°C. This is hot enough to cause a burn injury.
- b. **NEVER** get in the Hot Tub when SUPA heater is heating the water during the MODE 1 operation.
- c. **NEVER** take the red outlet hose out of the Hot Tub during the operation of MODE 1.
- d. **NEVER** put your hand/limbs in the flow of water from the red outlet hose during the MODE 1 operation.
- e. **NEVER** leave the Hot Tub unattended during the MODE 1 operation, especially when there are children or animals in the vicinity.
- f. In MODE 2, when using hot water, please ensure that the temperature of the hot water flowing out is not too hot for its intended use.
- g. In MODE 2, when testing water temperature, place your hand close to the running water to sense/feel radiant heat from the water's surface for suitability before placing any part of the body within the water flow. This is as you would do under normal circumstances to ensure it is suitable, before showering.
- h. During use and immediately after use, the water heater case should **not be touched by hand**.

- i. During and after use, the exhaust port, chimney and cowl are very hot. **Do not touch.**
- j. During use and for a while after use, the pump body and housing can be very hot, up to 90°C, when left on for a long time. **NEVER touch the pump, and keep children and animals away.**

## 7. GENERAL INFORMATION

- a. **ALWAYS** store SUPA heater in a garage or shed when not in use and for added protection use the cover provided. The cover is not sufficient protection to leave SUPA heater exposed to rain, wind and freezing temperatures outdoors.
- b. **ALWAYS** switch off the gas supply when not in use.
- c. **ALWAYS** drain SUPA heater after every use. To prolong your SUPA heaters life, please adopt this good habit! (see 19. ASSEMBLY - Step 9)
- d. If an unusual smell or sound is heard, immediately close the main gas valve and switch off the SUPA heater.
- e. The hot water supplied by SUPA heater is not suitable for drinking and can only be used for its intended use.
- f. To prevent accidents, children under the age of 18 years shall not use SUPA heater.
- g. Do not touch the electrical socket, earth leakage breaker and emergency operation buttons when your hands are wet.
- h. SUPA heater must not be used in rain or high winds.
- i. Do not block the inlet and outlet of the heater during use.
- j. Make sure the SUPA heater is located away from combustible materials.
- k. Never place cups, bottles or drinking glasses on the SUPA heater.
- l. If the temperature in SUPA heaters immediate surrounding drops below 5°C, the water within the heater must be drained to avoid expansion during freezing and potential internal weld failures. A failure to do this would render your warranty invalid. (See 19. ASSEMBLY – Step 9).

## 8. PRODUCT INTRODUCTION

Your SUPA heater is a forced-exhaust gas water heater. In use, the water heater fan forcibly discharges the flue gas generated by combustion, through the exhaust pipe, making it efficient and safer to use.

SUPA heater is ONLY suitable for outdoor use. When used outdoors, the heater MUST be completely sheltered from wind and rain, from all directions. The input airway and output exhaust flue must not be restricted. The exhaust gas generated must be discharged to the outside. This eliminates dangerous factors such as hypoxia and carbon monoxide poisoning.

Your SUPA heater incorporates many unique features:

- a. Intelligent High Anti-Wind Pressure Technology: Built-in intelligent high anti-wind pressure system to solve the problem of accidental flameout, and produces a continuous and consistent output

water temperature.

- b. Advanced Heat Exchanger: Utilises oxygen-free copper, delivering high-end efficiency and environmental protection.
- c. Water-Controlled Automatic Ignition: Water flow at a specific pressure automatically causes the heater to ignite.
- d. Water Temperature Adjustment: Varying output water temperatures can be adjusted between 25°C and 40°C for heating your Hot Tub (MODE 1), and between 25°C and 55°C for showering (MODE 2).
- e. Forced Exhaust: Forcing exhaust gas to the outside to provide consistent output water temperature.
- f. Low Water Pressure Start: low starting water pressure enables a wide variety of applications and uses.
- g. Flameout Protection: If the water heater accidentally goes out during use, the heater will automatically close the internal gas valve to ensure that gas will not leak.
- h. Water-Gas Linkage Control: When the water supply is interrupted or the water outlet valve is closed, the heater will automatically stop burning and shut down.
- i. Over-Pressure Protection: When the water supply pressure is too high, the water heater safety valve will automatically release the pressure to avoid damage to the heater.
- j. Topple Auto-Off: Should SUPA fall over, the unit will automatically switch off. Once stood upright, SUPA will continue normal operation.

## 9. ANTI-FREEZE PROTECTION

SUPA heater is NOT equipped with automatic anti-freeze protection. Any damage to SUPA heater due to internal freezing is not covered by your warranty.

When outside temperatures reach below 5°C SUPA heater MUST be drained of all water after each use, to prevent the pipes from freezing and bursting. (See 19. ASSEMBLY – Step 9).

## 10. OVERHEATING PROTECTION

When the temperature of the hot water from the heater is too high, the water heater will automatically close the gas valve of the heater and stop working.

## 11. TIMING PROTECTION

To avoid damage to your SUPA heater, when it has run continuously for 90 minutes, the heater will stop and will be required to cool for a minimum period of 15 minutes. Once cooling has occurred you can restart the system by resetting to the MODE and temperatures required.

## 12. INTELLIGENT CONSTANT TEMPERATURE

SUPA heater precisely controls the temperature of the burner using an internal microcomputer. In order to quickly reach and maintain the user's set temperature, the inlet and outlet temperature are constantly measured by a water temperature sensor. Instantaneous calculations are conducted to determine the amount of gas and the amount of air required in order to reach and maintain the set outlet temperature.

## 13. EASE OF OPERATION

Microcomputer intelligently controls SUPA heater: After turning on the power, press the ON key to start the water heater and set the required water output temperature. The microcomputer will automatically start the water heater (if SUPA heater is in a safe state), and you can quickly enjoy constant temperature hot water.

## 14. OUTLET WATER TEMPERATURE DISPLAY

During the heating process SUPA heater displays the temperature of water at the red outlet hose.

## 15. FLUE BLOCKAGE OR FAN FAILURE PROTECTION

When a flue blockage or fan failure occurs, the water heater will automatically switch off and cannot be turned back on until the fault is fixed.

## 16. AUTOMATIC FAULT DIAGNOSIS AND DISPLAY

The intelligent microcomputer monitors various safety devices, gas proportional valves and other components in real time. When a fault is found, the SUPA heater stops and the fault code is displayed, with a continuous "beep" See 23. ERROR CODES, for error codes and their related description.

The safety and protection performance of this product are all the conclusions drawn from laboratory conditions testing. In actual use, SUPA heater may be affected by the environment.

## 17. TECHNICAL INFORMATION

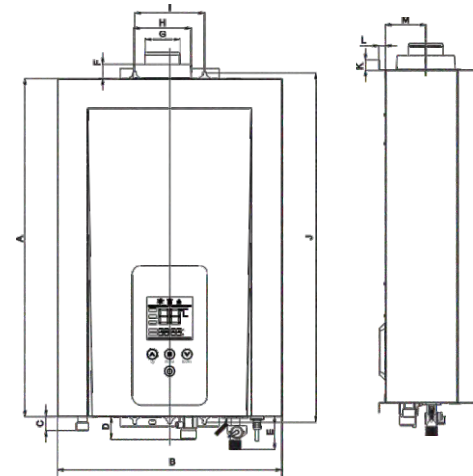
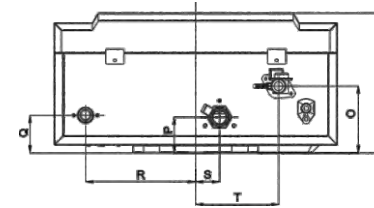

Machine	Dimension (mm)																			
	A	B	C	D	E	F	G	H	I	J	K	L	M	N	O	P	Q	R	S	T
16L	580	385	25	39	57	24	60	100	120	600	18	11	70	190	91	49	51	150	32	113

Part Name

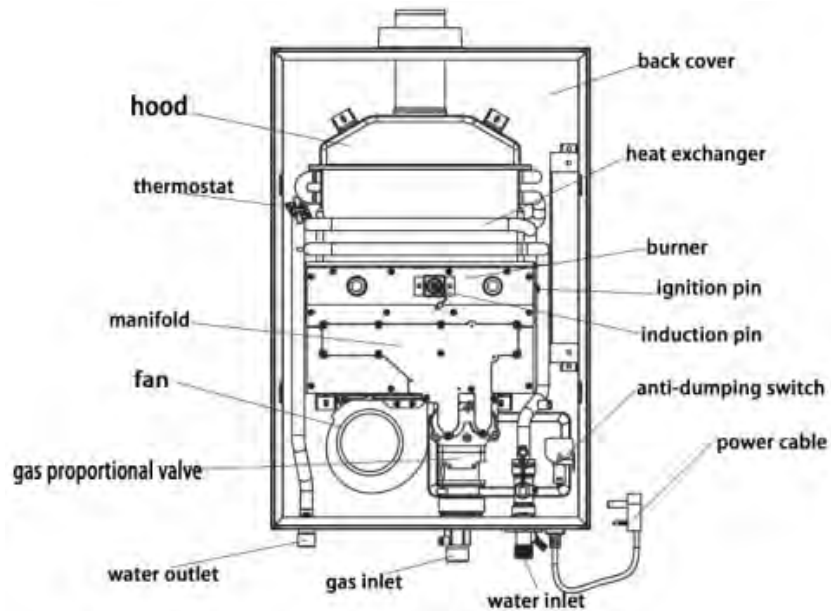

Gas parameter code table		
Gas	G31-3700Pa	
Liter	SP1001 SP1002	
Program code	FA	02
Max load PH	PH	PH-73-1150Pa
Min load PL	PL	PL-01-250Pa
Ignition DH	DH	DH-25-450Pa
Max load motor fan speed	FH	FH-9F-85Pa
Min load motor fan speed	FL	FL-3d-44Pa
Max load motor fan overspeed protection	HC	97
Min load motor fan overspeed protection	LC	60
Injector Dia.(mm)	φ0.5/0.8mm	

Product parameters

model	-	SP 1001 SP 1002			
rated power	kW	31			
minimal rated power	kW	6			
rated heat output	kW	27.6			
minimal rated heat output	kW	5.4			
rated heat efficiency	%	84%			
<b>Gas pressure</b>					
gas type	I3P				
Gas Category Type	G31				
gas pressure (mbar)	37				
destination country	BE, CH, CZ, ES, FR, GB, GR, HR, HU, IE, IT, LT, NL, PL, PT, SI				
<b>Gas flow</b>					
LPG(G31)	kg/h	0.3-1.7	0.3-1.9	0.4-2.3	
(15°C, 1013.25mbar)					
Flue gas rated flow	LPG(G31)	kg/h	52.7	58.9	71.3
Average flue gas temperature	LPG(G31)	°C	140	150	180

Product parameters continued

hot water data		
Rated hot water production capacity (Temperature rise: $\Delta t=25K$ )	L/min	16
max applicable water pressure	bar	8.5
minimal applicable water pressure	bar	0.25
circuit data		
power supply	-	AC: 220-240V, 50-60Hz
Rated electric power	W	43
waterproof level	-	IPX2 (for JSG31-16NT02)
Connection pipe specifications		
water inlet	inch	G1/2"
gas inlet	inch	G3/4"
water outlet	inch	G1/2"
Exhaust/Intake pipe	mm	$\phi 60 / \phi 100$
dimension/weight		
dimension	mm	580*385*190
weight	kg	15.6
Nozzle specifications		
Nozzle quantity (rich/lean)	pcs	18+18
G31Nozzle diameter(rich/lean)	mm	0.5/0.8

18. ELECTRICAL WIRING PLAN

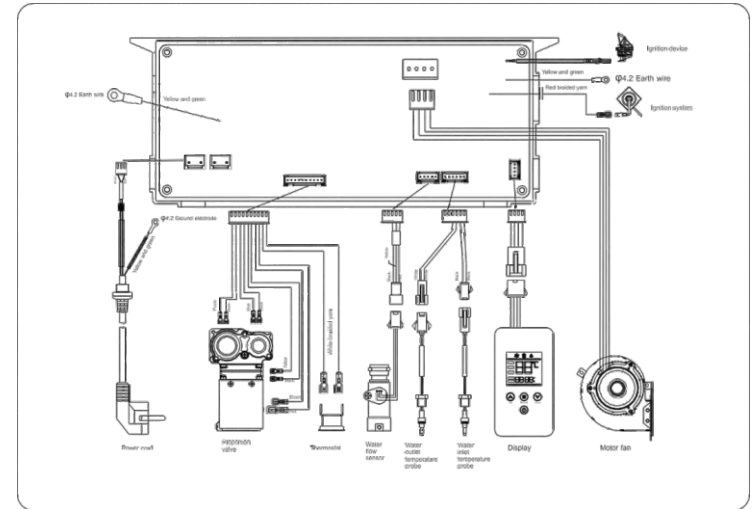

## 19. ASSEMBLY

Please follow the diagrams to assemble the mounting frame for your SUPA heater, fit the heater to the frame, mount the pump and assemble and fit the hoses. Assembly can be done by one person, but we recommend you have some help.

Screws and fittings for each element are included in numbered bags for ease. Start the process using bag 1 and in the following order. Do not overtighten screws/bolts.

The wheels are attached to the shorter legs which must be at the back, with the longer legs at the front

The rectangular plate on which the pump is mounted, looks like it can be installed left to right or right to left. The correct way is to attach the plate to the frame with the 4 x holes positioned to the left-hand side, when viewed from the front. See Figure below:

The hooks for the electrical cable ties are always pointing to the inside of the frame. See the Figure below:

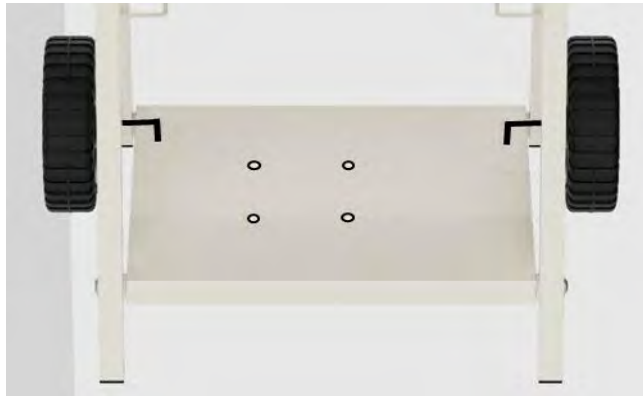

### Step 1 - Fitting the Top Horizontal Members to the Side Frame Members



### Step 2 - Fitting the Plate to the Front Feet (the Longer legs of the Frame)



**Note:** Do not fully tighten screws until completion of Step 3. In addition, the rubber anti-vibration washers should not be over-tightened and compressed too much, tighten to compress and secure but not to flatten!

### Step 3 - Fitting the Wheels to the Frame and Plate





#### Step 4 - Fitting the Pump to the Plate

**Note:** With the wheels at the back, please ensure the pump is positioned on top of the plate with the larger end of the pump facing to the right.

- a. Before inserting the bolt through the top of the black rubber isolation foot, insert a small washer and then a slightly larger washer on the bolt, then push the bolt through from the top. Underneath insert the white coloured anti-vibration washer, a steel washer then the nut.
- b. Tighten the nut to slightly compress the anti-vibration washer so it holds the pump tight, but for best effect do not over-tighten as that will increase vibration and noise. Don't lift or move the frame until all the bolts are in place, or the heavy pump will fall.

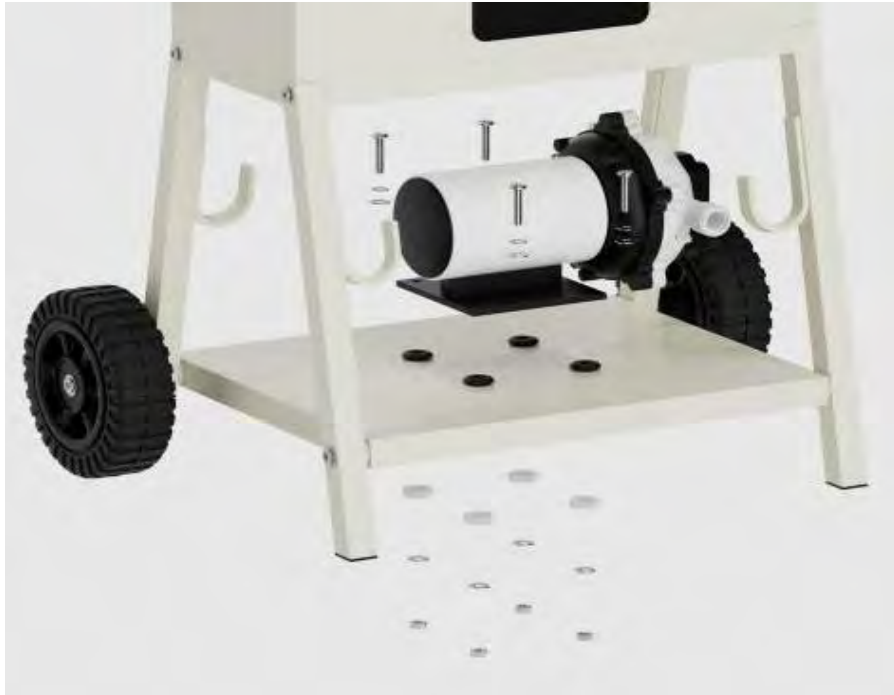

#### Step 5 - Fitting the Debris Filter

**Note:** When screwing the filter onto the water 'In' side of the pump, please ensure you do not over-tighten. It is also advisable to use a little PTFE tape over the threads to ensure a good water seal if you have any leaks (not supplied).



#### Step 6 - Fitting the Handle and Hooks to the Heater









## Step 7 - Fitting the Stand to the Heater

**Note:** Although 6 holes are provided in the top of the frame (underside), only 4 of these are used. Two at the back and 2 on the sides. – you are not missing screws and washers! In addition, DO NOT use power tools for this step, it may strip the threads in the heater.

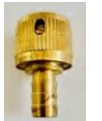

## Step 8 - Assembly of Hoses and Fittings

Assemble the hoses as shown in the following images –

<p>Figure 1. Figure 3. Figure 4.</p>		<p><b>Male Quick Connector. Connect to:</b></p> <ol style="list-style-type: none"> <li>1. Pump 'In' at pump, to one end of long blue hose.</li> <li>2. Water 'Out', left underside of heater to one end of long red hose.</li> </ol>	
<p>Figure 2.</p>		<p><b>Barbed connector. Connect to:</b></p> <ol style="list-style-type: none"> <li>1. Water 'In', right underside of heater, to end of short blue hose.</li> </ol>	
<p>Figure 2.</p>		<p><b>Pump barbed connector. Connect to:</b></p> <ol style="list-style-type: none"> <li>1. Water 'Out' of pump, to one end of short blue hose.</li> </ol>	
<p>Figure 3. Figure 4.</p>		<p><b>Female Quick Connector. Connect to:</b></p> <ol style="list-style-type: none"> <li>1. Both ends of the long Red hose</li> <li>2. Both ends of the long Blue Hose.</li> </ol>	
<p>Figure 1. Long blue hose to Pump 'In'</p> 		<p>Figure 2. Pump 'Out' to Heater 'In'</p> 	
<p>Figure 3. Heater 'Out' to long red hose – see male female connectors bottom left for illustration.</p> 		<p>Figure 4. Long blue hose to pump 'In' – see male female connectors bottom left for illustration.</p> 	

**Note:**

1. Please install the blue protective end clips supplied onto the ends of the metal fasteners to remove its sharp edges and protect any item they may come into contact with from scratching or tearing.
2. If you experience any leaks on threads, i.e. the water 'In', 'Out', Pump 'In' and Pump 'Out and Filter 'In', we suggest using a small amount of PTFE tape to assist with sealing (not supplied).

**Step 9 - How to Drain SUPA heater**

After each use of the heater, we highly recommend draining the water out of the system. This is mandatory in very cold areas or where the temperature may drop below 5°C. The water remaining in the water heater must be drained to avoid internal damage caused by freezing water, which can expand and rupture the heat exchanger element. Your warranty does not cover such damage. The draining method is as follows:

- a. Turn off the heater and unplug both the heater and pump from the electrical supply.
- b. MODE 1. Take out both the long red and blue hoses out of your hot tub. Lay them on the floor where you want the water to drain. Turn on the pump by plugging it in and wait 2 minutes until all the water from the heater and hoses has been pumped out. It will gurgle and splutter a little but nothing will be damaged.
- c. MODE 2. Remove the shower head or any adapter connected to the long red water 'Out' hose. Lay the hose in a place where you want to drain the water. DO NOT disconnect the short blue hose water 'In' or the long red hose water 'Out' at the heater. If you do this, then the water in the Heater will spill on the electrics of the pump. Instead, you must disconnect your garden hose pipe from the free end of the blue water 'In' hose to the pump. Turn on the pump by plugging it in and wait 2 minutes until all the water from the heater and hoses has been pumped out through the red hose. It will gurgle and splutter but nothing will be damaged.

**20. OPERATING INSTRUCTIONS**

**Important:**

Before using your SUPA heater you must ensure the water in the hot tub is clean and free of any debris that could potentially become lodged in the hoses or in the heater itself. SUPA Products will not be held liable for any failure of the product that is a direct result of this issue and the warranty will become void.

The pump inlet is provided with a Filter. This filter must be in place at all times. In normal use, this filter is intended to capture debris, which will begin to restrict flow of water, and consequently slow down your hot tub heat up times. Periodically take the filter out, clean it and put it back in. This will optimise water flow and minimise hot tub heat up times.

Additionally, if the filter is blocked and the water flow is too small, the heater may not be able to ignite or may switch off mid use.

This filter is not a replacement for your hot tub's existing filter and your usual water treatment regime.

**Very Important:**

SUPA heater will only work with a screw in gas regulator. It will not work with an easy-fit, clip on regulator.

When connecting electrical items to sockets you MUST ensure that both the pump and heater are connected to electrical outlets with built-in RCD circuit breakers. Extension leads with this facility are available from multiple leading retail outlets. Please also ensure that these as a minimum are CE certified and ideally UKCA approved.

**LED Control Panel**

**On / Off:** Switches your SUPA heater On and Off. Note: there is an automatic 'Off' after 90 minutes which will require you to press 'On' again to restart after 15minutes of cooling.

**Up:** Turns the temperature up by 1°C each time it is pressed.

**Down:** Turns the temperature down by 1°C each time it is pressed.

**Mode:** Switches between 'Mode 1' which recirculates, heats and regulates the water in your hot tub to the desired temperature and 'Mode 2' which will heat the water passing through the heater from your mains supply to the desired temperature (maximum increase from inlet temperature is approx. 25°C).

When operating and heating properly, the fan, water flow and flame symbols located above the top line (left to right) will flash intermittently. When the fan symbol is displayed and turning, the internal fan is balancing the temperature and exhausting burnt gases. When the water symbol is flashing water is flowing through the heater and when the flame symbol is flashing, the water is being heated.



Mode 1



Mode 2

**MODE 1 - To Heat Your Hot Tub:**

- a. Position the heater close to the tub.
- b. Ensure all connections are free of leaks before starting.

- c. Insert the free end of the blue (cold) and red (hot) hoses into the tub and ensure that they are as far apart as possible, so that the hot water from the red hose is not directly sucked into the cold intake blue hose.
- d. Plug in the SUPA heater and press the On/Off button on the LED display.
- e. Press the MODE button to select MODE 1.
- f. A preset temperature will flash on the LED display which is the temperature recorded under this MODE when last used. Whilst this is happening press the Up and Down buttons to fix the hot tub temperature that you require. In MODE 1 the temperature can be set between 25°C and 40°C. Once you have set your desired temperature, the temperature indicator will flash for 3 seconds, and then stop flashing then will display the internal temperature of the water currently in the heater.
- g. Plug in the pump which will immediately start – there is no on/off switch. Ensure that the water is flowing freely from the end of the red hose.
- h. The heater will not want to start because there is no gas supply yet. The water flow and fan icons will start to flash.
- i. Open the valve on the gas bottle supplying the heater. After a few short seconds, you will hear ignition of the gas and the flame icon will also start to flash.
- j. The temperature displayed on the display is the water outlet temperature, which can range between 20°C and 30°C ABOVE the current water input temperature. The output water temperature through the red outlet hose can reach 70°C. This is hot enough to cause a burn injury.
- k. Once the temperature in the hot tub reaches your chosen Preset temperature, the flame icon will stop and the burner will automatically switch itself off.
- l. Your existing hot tub heating system will take over now.
- m. Press the on/off button on the heater to shut it down, close the valve on the gas supply bottle and unplug the pump and heater from the electrical supply.
- n. Hoses and electrical cables can be wound around their hooks and your SUPA heater stored. Be careful when handling the pump or the chimney and cowl, they may be hot – DO NOT touch.
- o. We highly recommend SUPA heater is now drained to remove all water from inside your SUPA heater. (See 19. ASSEMBLY – Step 9)
- p. To maintain Hot Tub temperature, please use your Hot Tub’s built-in heater, as directed by your Hot Tub supplier.

- q. Under no circumstances should you enter your Hot Tub with the hoses remaining inside.

#### **MODE 2 - To Use Your Shower/Power washer:**

Make sure the hose from your water mains reaches the inlet end of the long blue water ‘In’ hose.

To ensure a leak free connection to the heater, we have supplied a spare ‘Female’ fast fitting for use on your garden hose which should already be fitted before this process starts.

- a. Connect your garden hose to the female fitting on the free end of the blue water ‘In’ hose.
- b. Attach the shower head to the female fitting on the free end of the red water ‘out’ hose.
- c. DO NOT open the external mains tap at this stage.
- d. The hoses, pump and heater supplied with your SUPA heater are suitable for normal water pressures. Mains water pressure around the country is usually between 1 to 5 bar and 10 to 15 litres per minute. However, it can exceed this. To ensure that the system performs satisfactorily and is not damaged, depending on the pressure of your water supply we strongly suggest that the water tap is opened slowly at first to allow you to gauge the water flow to the system and out of shower head.
- e. Assess water flow by pressing the on/off button on the shower head to allow water to flow. Once you are satisfied, turn the shower off using the on/off button again.
- f. Open the gas valve to supply the SUPA heater.
- g. With the SUPA heater plugged in and switched on, select MODE 2 by pressing the MODE button until the number 2 is indicated on the LED screen.
- h. Press the Up and Down arrows until the desired temperature is displayed. In MODE 2 the temperature can be set between 25°C and 55°C. At this point the temperature will flash for a period of 3 seconds and then stop to indicate this target temperature is now recorded and set.
- i. You are now ready to shower. As you press the on/off button on the shower handle to allow water to pass through the shower, the SUPA heater will start to operate and within 10 - 15 seconds the temperature of the outlet water will be regulated around the temperature you have set. This temperature will fluctuate 1 to 2°C as the heater balances.
- j. Before showering you must check the temperature of the water at the shower head; place your hand close to the running water to sense/feel the radiant heat from the water’s surface for suitability, before placing any part of the body within the water flow. This is as you would do under normal circumstances to ensure it is suitable, before showering. Whilst operating, you can press the Up and Down buttons to increase or decrease the temperature of the water

according to your needs.

- k. When you are ready to stop, press the stop button on the shower head, close the mains water supply and repeat steps m. n. and o. as for MODE 1, before storing your SUPA heater out of the wind and rain, with its cover on.

## 21. GENERAL MAINTENANCE

- a. Please check all electrical cabling before each use. Any damage should be repaired only by a suitably qualified electrician.
- b. Frequently check whether the gas supply pipe (rubber hose) is intact, whether it is aging or cracking etc. If anything looks damaged, then please replace before further use.
- c. Every twelve months, we suggest you appoint a qualified professional gas safety technician to check the heat exchanger for carbon deposits and blockages, and perform a general inspection of the heater.
- d. When the ignition pin is found to have carbon deposits, please have a qualified professional technician maintain it to ensure the ignition quality.

## 22. USER MAINTENANCE AND INFORMATION

- a. The water heater uses a water flow detection device to open the internal gas valve. When the water pressure is lower than 0.02MPa, or the water output is too small, the water heater does not ignite – this is normal.
- b. The pressure relief valve (drain valve) drips water because the pressure of the water supply is too high, the pressure relief valve (drain valve) plays a protective role by reducing the water pressure to protect the water heater - this is normal.
- c. If used when the outside temperature is approaching freezing, the exhaust gases may condense into a white mist - this is normal.
- d. When water flow is reduced, the output temperature may be too high. Please ensure there are no blockages and all parts of the system are working effectively.
- e. When the supply of flowing water through the heater ceases, the heater will stop working immediately. At this time the internal fan will continue to operate for a short period of time before shutting down.
- f. If the wind is gusting too strongly, excessive pressure will be measured by the internal control system and the protection system will force the heater to shut down temporarily. Normal operation will commence when external wind conditions allow.

- g. In order to reduce the formation of lime scale, after each use of the heater, please allow the hot water in the heater to fully flow out of the hot water outlet.
- h. After each use of the heater we highly recommend draining the water out of the system. This is mandatory in very cold areas or where the temperature may drop below 5°C. The water remaining in the water heater must be drained to avoid internal damage caused by freezing water, which can expand and rupture the heat exchanger element. Your warranty does not cover such damage. (See 18. ASSEMBLY – Step 9).
- i. Always keep the water heater's case clean by using a wet cloth and drying immediately.

### 23. ERROR CODES

When the heater fails to operate you will see an error code displayed accompanied by a continuous 'beep'. When this occurs please refer to the following tables:

Error	Failure	Treatment
E0	Water temperature probe failure: <input type="checkbox"/> Water inlet temperature probe is damaged; <input type="checkbox"/> Hose has detached or there is a poor connection and leaking.	<input type="checkbox"/> Replace the water temperature probe. <input type="checkbox"/> Check and ensure that all connections of hoses are suitable.
E1	Ignition failure: <input type="checkbox"/> Ignition does not start after two consecutive ignitions. <input type="checkbox"/> Accidental flameout during ignition or the flame detection line has detached or there is loose contact.	<input type="checkbox"/> Restart the water heater and repeat several times. If it still fails, check whether the gas valve is open or the air supply circuit pressure is abnormally low or with no pressure <input type="checkbox"/> Replace malfunctioning parts.
E2	False ignition fault: <input type="checkbox"/> Fame signal detected before ignition.	<input type="checkbox"/> Restart the heater and repeat several times. If it does not light, replace the sensor pin or the controller.
E3	Thermostat failure: <input type="checkbox"/> Temperature controller overheating protection. <input type="checkbox"/> The temperature controller is damaged or the line connector is disconnected or has a poor contact.	<input type="checkbox"/> Check whether the air supply circuit pressure is normal, eliminate the fault, and restore the normal pressure; increase the water supply pressure or lower the hot water set temperature; <input type="checkbox"/> Replace thermostat, install patch cord
E4	Water temperature probe failure: <input type="checkbox"/> Water inlet temperature probe is damaged. <input type="checkbox"/> Line connector comes off or has poor contact.	<input type="checkbox"/> Replace the water temperature probe; 2.Plug in the line connector.

E5	Fan failure: <input type="checkbox"/> The fan has stuck and stopped. <input type="checkbox"/> The fan is damaged. <input type="checkbox"/> The fan power control component is damaged. <input type="checkbox"/> The line connector is disconnected or has poor contact.	<input type="checkbox"/> Clear the sundries and eliminate the stuck faults; <input type="checkbox"/> Replace the fan; <input type="checkbox"/> Replace the damaged parts (relevant components on the power board and main electric control board); <input type="checkbox"/> Install the patch cord or replace defective parts.
E6	Over-temperature fault: <input type="checkbox"/> Water temperature sensor overheating protection.	<input type="checkbox"/> Check whether the air supply circuit pressure is normal, eliminate the fault, and restore the normal pressure; increase the water supply pressure or lower the hot water set temperature.
E7	Solenoid valve failure: <input type="checkbox"/> The line connector is disconnected or the contact is bad or damaged. <input type="checkbox"/> The control line has components damaged.	<input type="checkbox"/> Install the patch cord and replace the bad parts 2.Repair / replace damaged parts.
E8	Fan over-speed failure: <input type="checkbox"/> The smoke exhaust port is blocked. <input type="checkbox"/> It is windy outdoors and the wind pressure is too high.	<input type="checkbox"/> Clear the obstruction of the smoke exhaust port. <input type="checkbox"/> Suspend the use of the water heater and wait until the outdoor wind pressure is normal.
En	Scheduled shutdown:	<input type="checkbox"/> Turn off the water supply and heater and restart after 15 seconds.
<p><b>If the above error code appears, all checks are normal, and it can't resume normal use even after power off and restart then please notify SUPA customer service by e-mail detailing purchase date, batch code and error message together with proof of purchase.</b></p>		

**GENERAL ISSUES**

Issue	Cause and treatment
White smoke from exhaust.	<input type="checkbox"/> The outdoor temperature is too low and the exhaust smoke condenses it to a white mist when it meets the cold outdoor air. No action required.
The amount of hot water is too little or the hot water flow becomes cold.	<input type="checkbox"/> Insufficient flow causing the heater to switch off. Increase the flow.
Failure to supply hot water during winter conditions.	<input type="checkbox"/> SUPA heater can generally raise the temperature of the water by a maximum of 25°C unless the water flow is reduced. If the temperature of the inlet water is too low and the target temperature is higher than 25°C above this temperature then the target temperature exceeds the performance of the heater.
When closing the hot water valve, the fan does not stop immediately.	<input type="checkbox"/> This is normal operation to ensure that the fan completely exhausts all gases from the flue.
Water often flows out of the pressure relief valve.	<input type="checkbox"/> This is because the water pressure in the heater is too high, the safety pressure relief valve is actually working, and allowing the excessive pressure to be released

Common Improper Operation and Potential Solutions		
Issue	Potential Cause	Potential Solutions
Ignition failure	Gas pressure is too high or too low.	Check the correct regulator is being used. SUPA heater will only work with a screw in gas regulator. It will not work with an easy-fit, clip on regulator.
	Blocked flue or excessive external wind pressure.	Clear the blockage or start use only after the wind pressure has reduced.
	Water source not connected.	Turn on the water or connect the water supply.
	Insufficient water pressure.	Check and adjust the water pressure/flow.
	Power is off.	Switch the power on.
	Gas is not switched on or fully used.	Switch on the gas or change/refill the bottle.
	Air lock in the gas pipe.	Exhaust before turning on the water heater.
	Water temperature is too low	The water flow is too high and exceeds the heating capacity of the water heater.
Insufficient gas pressure.		Switch on the gas or change/refill the bottle.
The gas valve is not opened sufficiently		Fully open the gas valve.
Water temperature is too high	Water heater temperature is set too high.	Lower the water flow temperature.
	Water flow is too low.	Increase the water flow.
No hot water comes out even if the hot water switch is turned on	The water inlet valve is not opened sufficiently.	Open the water outlet valve further.
	The first time being used.	Turn the water heater on and off several times.
	Icing.	Allow to thaw and inspect for leaks before use.
	Water or power outages.	Use only after normal water and electrical supply have resumed.
	The pipe from the water heater to the water outlet is too long	Wait for a while after the water heater is started.
	Water heater temperature is set too low.	Increase the outlet temperature.